

# Optimal power dispatch capability and reliability analysis of hybrid renewable energy system



K. Uma Maheshwari<sup>a</sup> | P. Vijaya Lakshmi<sup>b</sup> | A. Nagaraju<sup>c</sup> | Subrahmanyam Kothagundu<sup>c</sup>✉

<sup>a</sup>Department of Mathematics, Srinivasa Ramanujan Institute of Technology (Autonomous), Anantapur.

<sup>b</sup>Department of Mathematics, Gates institute of technology, Gooty.

<sup>c</sup>Department of Mechanical Engineering, JNTUA college of Engineering, Anantapur.

**Abstract** These days, using solar and wind energy resources is much more cost-effective and appealing. The rapid depletion and growing expense of non-renewable energy supplies resulted in the development of alternative energy sources that utilize renewable energy sources. In recent times, hybrid renewable energy algorithms have often been connected to wind and solar power systems. The primary objective of this work (PWBHPS) is to determine the power dispatch capacity of a PV-wind-battery hybrid power system. In the modern electric power market, the PWBHPS's power dispatch capacity needs to be explicitly specified at the beginning of every dispatching time interval in order to collaborate with the transmission system operator (TSO). Energy storage is a workable option for efficiently integrating renewable energy sources into the system. A recently developed storage device called the vanadium redox flow battery (VRFB) may have certain advantages in large-scale grid-connected applications. State-of-charge monitoring provides extra insights into battery performance by displaying increased capacity utilization and longer cycle times, both of which extend the life of the cells. This study looks at the minimum-max technique of individual solar energy, wind energy, and a combined PV wind battery hybrid power system to size a VRB battery for application in renewable energy systems. Individual wind and solar systems need larger battery capacities for consistent, constant power output; hybrid systems require batteries with lower ratings. An optimal charging mechanism is proposed and explored through MATLAB simulations.

**Keywords:** flow of battery, VRB, solar-wind energy, power dispatch method, size of battery

## 1. Introduction

Everyone requires access to dependable energy sources, regardless of time or location. In the twenty-first century, when people are continuously looking for methods to raise their standard of living, this is particularly true. One of the most important kinds of energy that society uses daily is electricity. Renewable energy uses in the form of clean technology may be the best answer to the energy crisis of the twenty-first century due to the scarcity as well as pollution of the energy that is produced. Applications utilizing clean renewable energy technologies, such as photovoltaic (PV) energy and wind energy, have been rapidly developed in recent years to satisfy the expanding demand for conventional energy sources compared to either wind or solar electricity alone, a hybrid system is far more likely to be ready to provide steady power. Customers may obtain power solutions that are more affordable, ecologically friendly, or that provide higher quality and reliable electricity by using distributed generating technologies (Engineering: Issues, Challenges, and Opportunities for Development 2010). "Distributed generation," or "DG," is a cutting-edge and effective method of producing and delivering electricity that makes use of several small-scale power sources that are either installed on the premises of customers or are connected to a distribution network. Power plants may now be built with more efficiency, at a lower cost, and with less impact on the environment thanks to technological breakthroughs. Due to the erratic nature of wind and solar radiation, standalone wind and PV renewable energy systems frequently require energy storage systems or additional power sources to function as a hybrid system (Nameer and Khafaf 2023). By offering clients power that is of higher quality and more stable, hybrid alternative energy systems, which integrate the best qualities of several renewable energy sources, have the potential to greatly improve systems based on a single resource. A standalone system with a few loads and a single renewable hybrid generation unit with a battery bank is looked at to streamline the study and generalize the findings (Maghami 2023). In this instance, the battery serves as the VRB. The ESS ensures a secure and stable electrical grid. For electricity networks to run efficiently, it's also essential to maximize the size of renewable sources such as solar panels, wind turbines, and battery storage. With sufficient PV power generation, wind power generation, and battery banks, users' load demands can be met. They might also increase the cost of a hybrid microgrid at the same time (Ahead 2017). However, when battery banks, wind turbines, and PV electricity are insufficient, they cannot support the required load from customers. Energy storage technologies have played a significant role in eliminating these hiccups and enabling the transportability of wind power. Due



to the intermittent nature of wind energy, storage that can quickly absorb and transmit electricity is required. Additionally, only during the day can solar electricity be used, and even then, it is dependent on cloud cover and other environmental circumstances. Large-scale storage alternatives like compressed air and pumped hydro require significant financial investments and are highly site-specific. Alternatives for quick responses like flywheels and supercapacitors have low power ratings and slowly deplete themselves. Battery storage units are the best choice for usage with renewable energy sources because this is the case. While another battery carried the load as it depleted, one was used to store wind energy (Leahy 2010). Both batteries exchange positions when their State-of-Charge (SOC) restrictions are reached. The planned dispatch strategy aimed to reduce the number of storage switches while also maximizing the supply of wind energy. A single BESS can perform similarly to a dual BESS thanks to coordinated dispatch, as suggested by Yang Li (2020). Then, to save upfront costs, we optimize battery size for scheduled shipment. The goal of this study is to evaluate the benefits of using a specific VRFB system to decrease PV-wind power forecasting errors through two interconnected tasks. The practicality of the VRFB technology has already been demonstrated in several projects in various regions, with applications ranging in size from a few kilowatts to a few megawatts. The technical viability of the VRFB has been successfully proven; now is the time for a more in-depth investigation and precise system-level upscaling. To extend battery life and reduce costs, I created a dispatch schedule whereby battery storage is alternately operated to give minimal as well as maximum wind power. The aforementioned process was altered to prolong battery life and reduce wind power mistakes. The research also used an optimization technique centered around the life cycle cost function to reduce battery size. Another example of how the system will react to changes in wind farm output is short-term electricity dispatch control. Abdullah et al.'s simulations employed a dispatching technique based on programming that took varying wind velocities and energy costs into account (Alexandre Lucas 2016). Battery energy storage systems (BESS) have been shown to work better than individual batteries. Two battery storage devices were used in the hybrid system's operation. One battery was used for storing wind energy, with another battery carrying the burden as it discharged. When both batteries' maximum State-of-Charge (SOC) values are achieved, the batteries switch places. The intended dispatch plan sought to maximize wind power supply while minimizing storage interchanges. Therefore, to reduce initial expenditure, we maximize battery capacity following the scheduled dispatch (Divya 2009).

1.1. Modeling of System Components

An illustration of a hybrid wind PV battery system is shown below. Electricity generated by wind and solar energy must be fed into the grid (Figure 1).

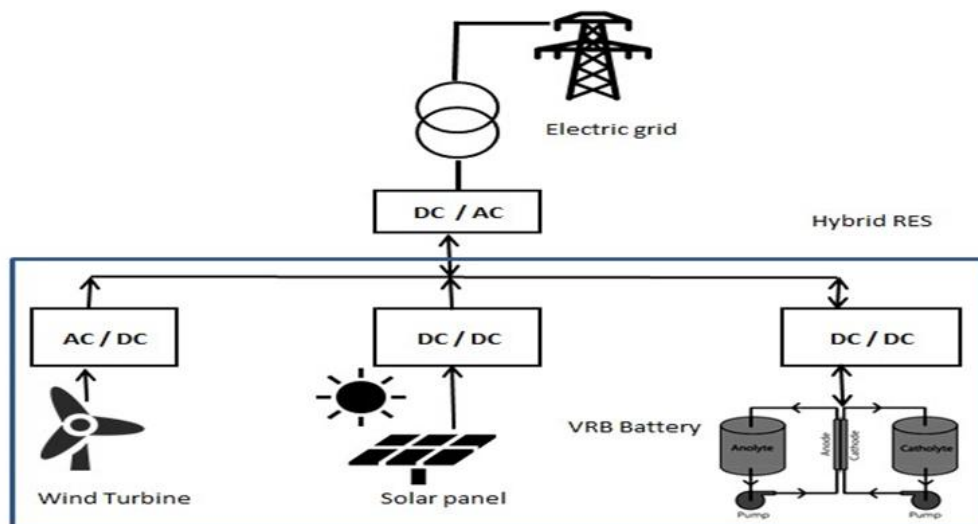

Figure 1 Block diagram of Grid connected hybrid renewable energy system.

2. Modeling Of Flow Battery – Vanadium Redox Battery

The most commonly used type of flow battery is a vanadium redox battery. According to predictions, flow batteries will account for 20% of the market for future energy storage, and VRB will lead the way in this area. Since vanadium is the only electrolyte, contamination is eliminated, and it can operate for many tens of thousands of cycles. The battery's lifespan will be extended, and it should last for more than 20 years as a result. A VRB battery that was put in place in Alaska has completed more than 20,000 cycles. Figure 2 shows how a VRB battery is put together, emphasizing the electrolytes as well as the operating cycles. Additional electrolytic tanks could be added to increase the energy capacity, and additional cell stacks must be constructed to increase the power capacity (Puleston et al 2022).



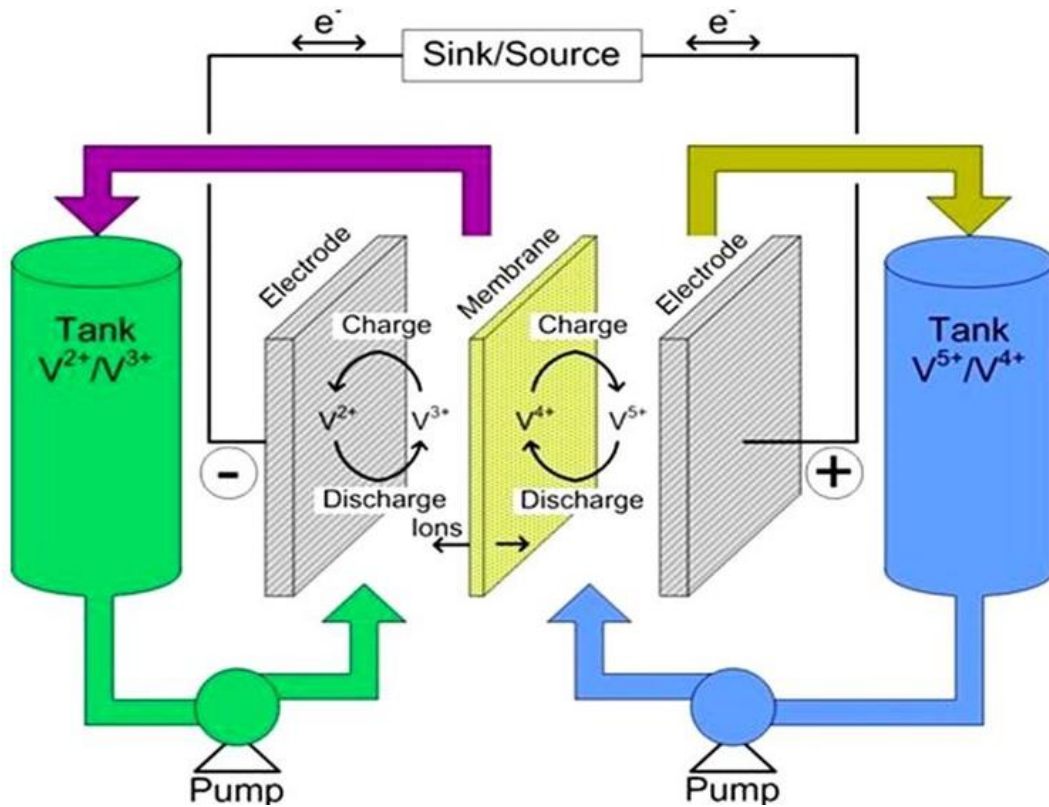
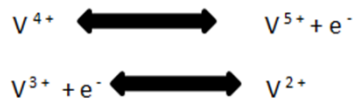

Figure 2 Vanadium Redox Battery.

For the anode and cathode-side electrolytes in VRB, two different kinds of vanadium are dissolved in diluted sulfuric acid in varying quantities. In four oxidation states, vanadium can be found in nature. This is what the battery system uses, and the redox equations that take place in the cell are as follows:



... (1)

Due to oxidation during charging, electrons are released at the anode, while reduction action takes place at the cathode. During discharge, the process is completely turned around. Ontiveros and Mercado (2014) and Baccino et al (2014) provide some studies that attempted to model VRB batteries (2014). Here, stack voltages, currents, and internal resistances of VRB batteries are assessed. It takes into account both internal and parasite resistance. Electrode/membrane resistances, electron mobility, and electrolyte contamination losses are examples of internal resistances. The losses that occur in a system when it is not in use are known as parasitic resistances, and they typically involve external circulating resistances. Nernst equation is used to compute battery stack voltage (Boss, 2018).

$$SOC(t) = SOC(t-1) \pm \frac{V \cdot I \cdot \Delta t}{E_{max}} \quad \dots (2)$$

Where  $V^{eq}$  is the equivalent stack voltage which is given by the product of some cells in the stack and the individual cell voltage  $V_{ell}$ .  $R$  is the gas constant,  $T$  is the temperature, and  $F$  is the Faraday constant.  $SOC$  is the state of charge of the battery which is given by MATLAB Simulink environment as shown in Figure 3.  $R_{eq}$  is estimated to be 0.75 ohms or such. It was believed that each stack would have 40 series-connected cells, each with a 1.5V cell voltage. As seen in Figure 3 the VRB is tested with a 1 kW PV supplying a 1 kW load. By keeping an eye on the SOC levels, a straightforward controller block was used to prevent overcharging and undercharging of the battery. The switches linking the PV panel and the load with the batteries are controlled by complementary control signals C1 and C2 from the controller block. Signal C1 changes to 0 and C2 changes to 1 when the SOC reaches the maximum level, disconnecting the PV and connecting the load to the battery for discharging. Similarly, to this, the control signals switch on and allow the battery to be charged when SOC falls below a certain threshold. The SOC's upper and lower bounds are set at 80% and 20%, respectively.



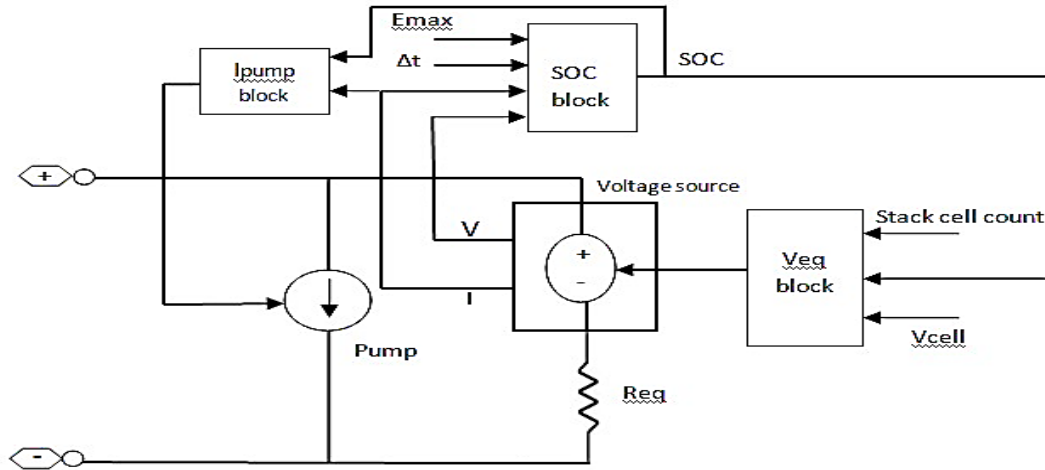

Figure 3 Model of VRB Battery.

### 3. Sizing of VRB Based on Power Dispatch

#### 3.1. Scheduling of Wind-PV Power Based on Max-Min Dispatch Strategy

Suggested the max-min dispatch technique for distributing power produced at a wind farm and assessing the necessary battery storage capacity. To minimize the size and extend the battery's useful life, Nguyen et al. (2015) improved this method. To ensure that the battery went through all of its charge and discharge cycles, the power dispatch was prolonged. Throughout the full dispatch, there are distinct times. Regarding the battery storage capability for a wind farm, they suggested using the Min-Max method for power dispatch. To ensure that the storage of batteries sees different charging and discharging times, power dispatch is designed to be dependent on battery operation. Because the power dispatch is set using the min-max method to ensure the scheduled discharge intervals occur whenever there is the greatest demand, the hybrid system may be able to provide electricity throughout these times and help with load balancing. (Chun, 2015).

Step 1: The choice of time interval "Td" to guarantee that the battery is never fully charged or discharged. On the time scale, it is often configured to be an hour, and the power dispatch curve will be smoother than the time interval smoothness.

Step 2: The number of periods, "N," determines how many data sets are generated from the created power profile.

Step 3: The Minimum and Maximum power released is defined for each interval denoted by the letter "i". Let P gen stand for the renewable energy produced by the wind-photovoltaic device.

For discharging:

$$P_{pd}^i = \text{Max} (i-1)_{T_d < t < iT_d} \{ P_{gen}^i (t) \} \tag{3}$$

For charging:

$$P_{pd}^i = \text{Min} (i-1)_{T_d < t < iT_d} \{ P_{gen}^i (t) \} \tag{4}$$

#### 3.2. Sizing Strategy for VRB

The generated power in VRB (vanadium redox flow batteries) is equal to the total of the power dispatch curves to maintain a power balance in the system.

$$P_{b(t)} = P_{gen} (t) - P_{pd} (t) \tag{5}$$

For discharging

$$P_{dis(t)}^i = P_{gen}^i (t) - P_{pd}^i (t) \tag{6}$$

$$P_{dis(i)}^{rat} = \text{Max} (i-1)_{T_d < t < iT_d} \{ P_{dis}^i (t) \} \tag{7}$$

For charging

$$P_{ch}^i (t) = P_{gen}^i (t) - P_{pd}^i (t) \tag{8}$$

$$P_{ch}^{rat} [i] = \text{Min} (i-1)_{T_d < t < iT_d} \{ P_{ch}^i (t) \} \tag{9}$$



#### 4. Integration and Energy Management of The VRB System

To investigate the integration and functionality of the battery with the HRES, simulation is used. There is a 200-kW wind turbine and a 75-kW solar panel in the wind-PV system under consideration. The power curves that display the power produced by the wind-PV systems over 24 hours are as follows. This graph clearly shows how wildly variable the HRES power is and how drastically the generation and load curves are out of sync. A power dispatch curve is computed using the max-min technique described in the step before, as shown. At off-peak hours, the dispatch is firmer and smoother and makes some effort to conserve power. In this case, N is 24 and Td is 1 hour. The battery is sized based on this dispatch curve by calculating the power that needs to be charged or discharged from the battery. P<sub>bess</sub> rated is determined to be 124.63 kW or around 45% of the wind-PV system rating. With the battery converter efficiency factored in, the energy capacity is predicted to be around 75% efficient and comes out to be 28 kWh (Xiangguo Xu, 2023).

#### 5. Results And Discussion

The sections explain the parameters and methods for evaluating VRB battery storage that will be incorporated in a Wind PV hybrid energy system within southern India. The 285-kilowatt wind generators utilize a fixed-speed asynchronous mechanism. To be integrated into the electrical infrastructure, the hybrid system is coupled with a 75kW solar panel. The exact findings are listed below.

**Table 3** Model of VRB Battery.

Modes of Operation	Description
Mode 1 (PV & battery)	PV-generated electricity There's more to a subsystem than just meeting its load requirements. Additional energy is stored by charging batteries.
Mode 2 (PV & battery)	PV power output is below load requirements. The battery provides the necessary electricity.
Mode 3 (Wind & Battery)	Wind-based energy production Any load need can be met by the subsystem on its own. If wind energy production falls short of the peak demand for electricity. The battery provides the necessary electricity.
Mode 4 (Battery only)	With no renewable energy sources available, the battery must be fully depleted to meet the required load.

##### 5.1. Sizing Strategy for VRB

Many inputs, including battery power, wind power from a wind generator, and solar power from a photovoltaic cell (VRB). When solar irradiation reaches its greatest magnitude, it is evident that there is a sizable difference between the maximum peak power and the peak demand. For these purposes, VRB storage excels. To release energy when there is a need for it most—during times of low demand. A quick charge or discharge response is required to balance the voltage and current of the generated power. A power dispatch must be performed to establish the size of the battery required to perform these operations (Figure 7). A closer inspection reveals that the minimum and maximum quantities of generated power are transmitted following both the states of the batteries and that the dispatched power is an average total version of the wildly fluctuating generating power curve in Figure 8. According to table 1 solar data, the system's solar rating is 75 kW, and 20 kW of battery power is needed to power the load (Figure 9). To keep the load powered up as solar irradiation decreases in the late afternoon and night, the VRB must discharge. The battery is charged by the PV during the day until it reaches the maximum state of charge (SOC<sub>max</sub>). After sunset, the battery starts its natural discharge and goes through to the load until the SOC<sub>min</sub> condition is reached.

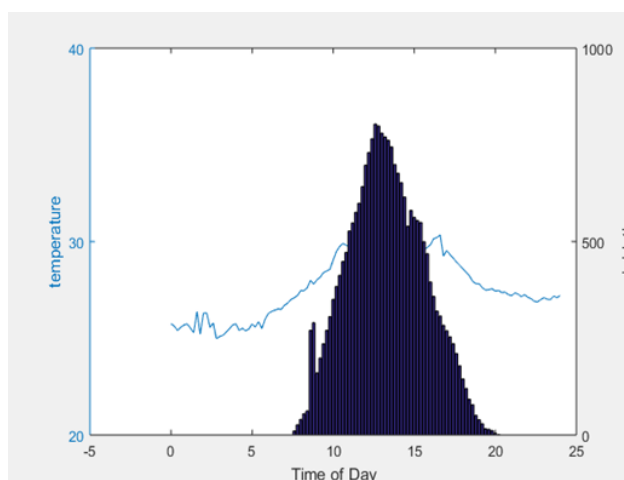

**Figure 4** Time of Day vs Temperature and Irradiation.

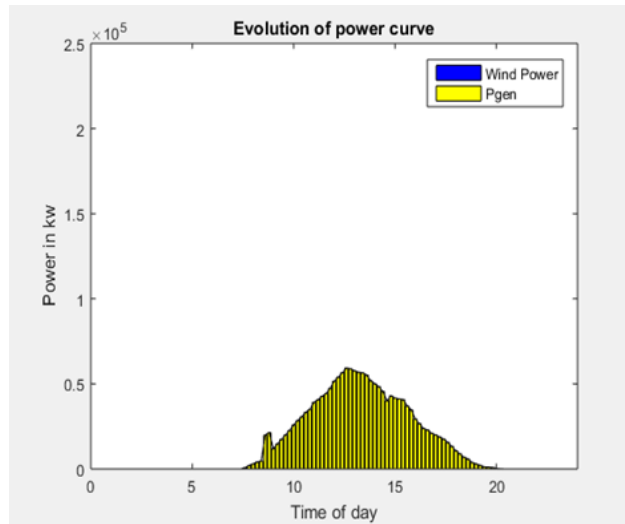

Figure 5 Time of Day vs Power in kW.

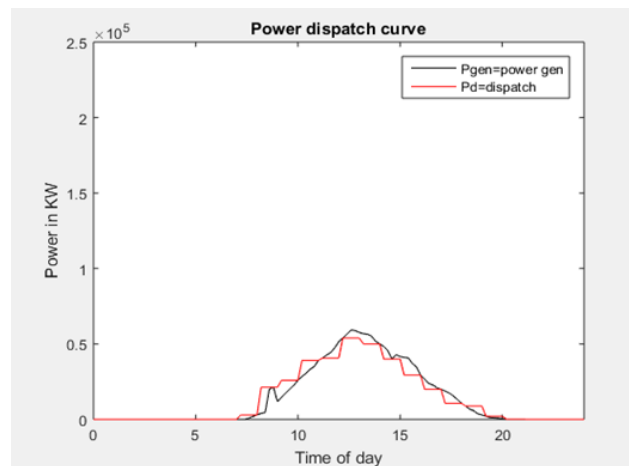

Figure 6 Time of Day Vs Power (Kw) or Power Dispatch curve of Solar Energy.

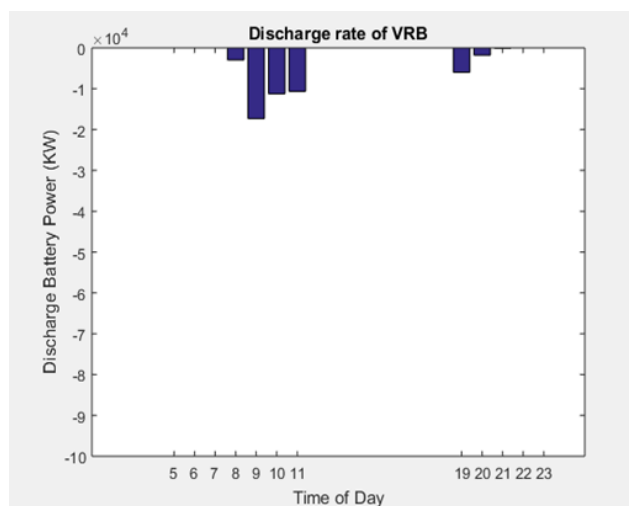

Figure 7 Model of VRB Battery.

### 5.2. Wind power system

The power dispatch curves for wind energy are depicted in Figure 10 above. The battery gets charged more when Pgen exceeds Ppd; otherwise, the battery is discharged to make up for the power shortfall. Only 12 hours are allowed for maximum electricity generation and distribution. The electricity dispatch, generation, and charging and discharging processes were all identical. The time-of-day vs. battery capacity of wind energy is depicted in Figure 11 above. The maximum power discharged and connected to the grid at 6 hrs. of the day was 80 kW, and the minimum at 5 hrs. and 20 hrs. was 10 kW. The

discharge power was measured in negative. The above Figure 12 shows the charging power of wind power energy, which was measured in kW. The maximum power charged and stored by the battery at 2 hours of the day at 10 kW minimum was at 3 hours and 4 hours of the day at 4 kW. Compared to solar, wind charging was fast. Maximum power rating at 2 hours at 180 kW and minimum at 5, 11, or 20 hours at 100 kW. The power rating measures the instantaneous demand they can supply. Because their active species always remain in solution during charge and discharge cycling.

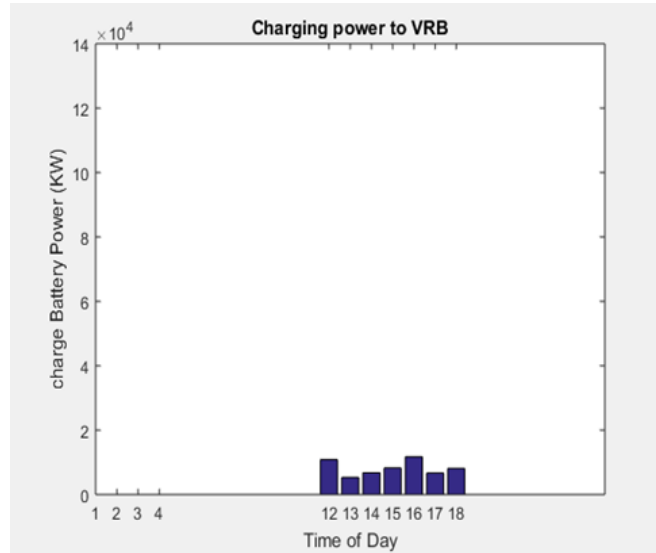

Figure 8 Time of Day vs Charging Power to VRB.

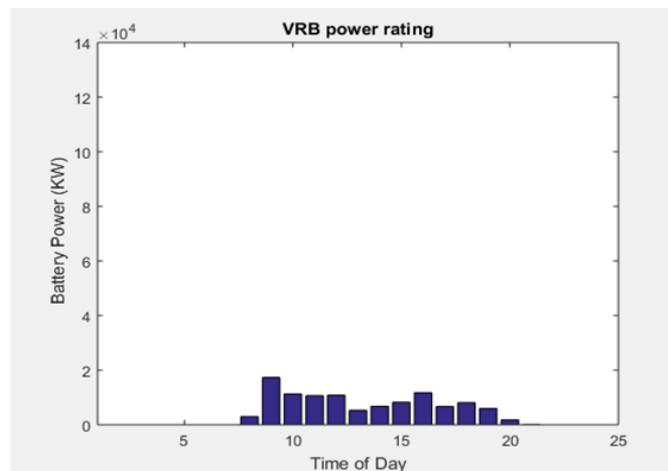

Figure 9 Time of Day vs VRB Power rating.

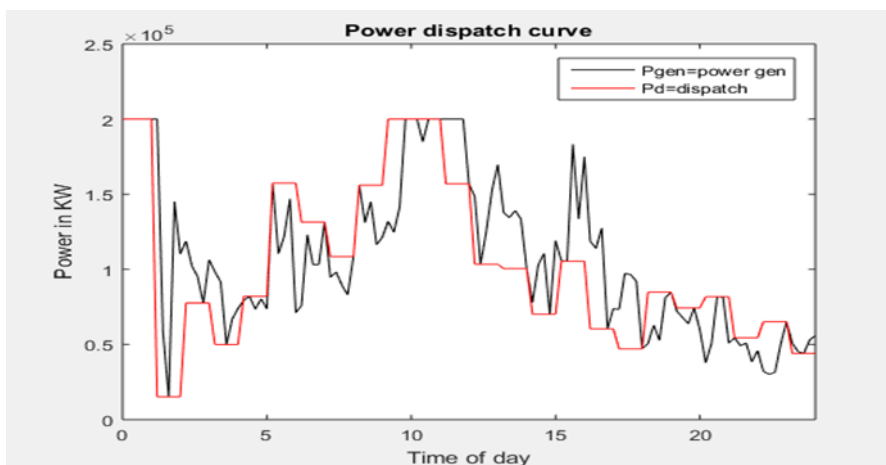

Figure 10 Time of day Vs Wind power (Power dispatch curve).

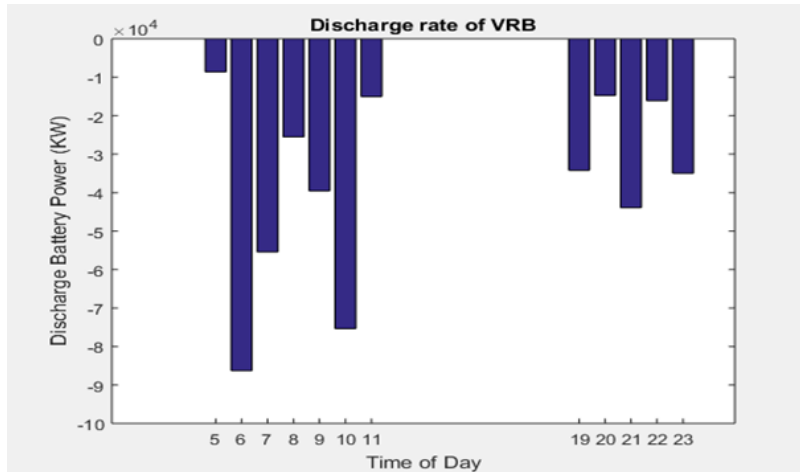

Figure 11 Time of Day vs Discharge Battery power.

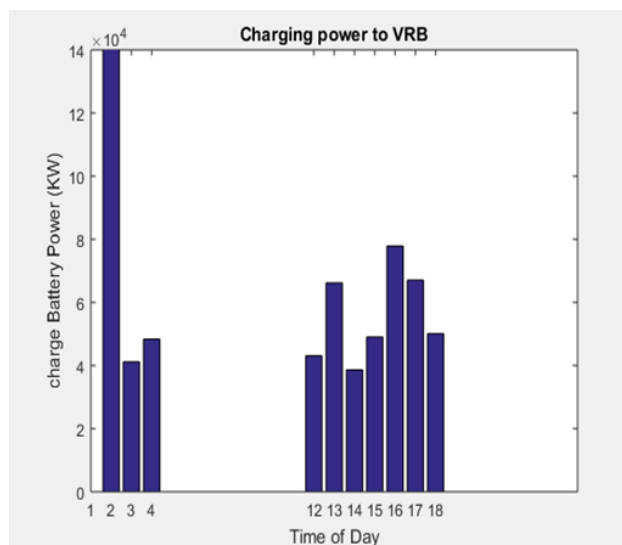

Figure 12 Time of Day vs Charge Battery power (KW).

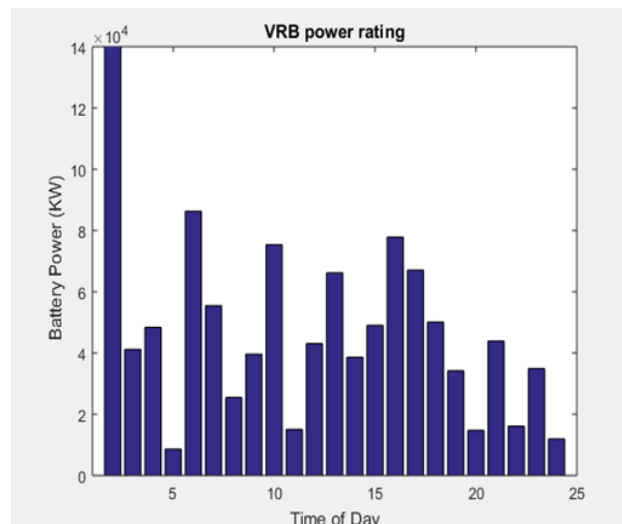

Figure 13 Time of Day vs VRB power rating.

### 5.3. Hybrid Power System

The above Figure 14 shows the Time-of-Day vs Power (kW) (solar and wind) generation. The maximum at 12.5 hrs. at solar is 600kW and wind power is 200kW.





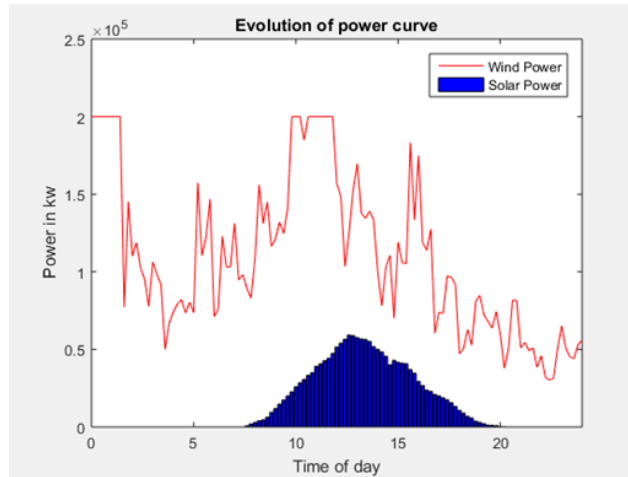

Figure 14 Time of Day vs Hybrid power system.

The above Figure 15 shows the power dispatch curve of the hybrid power system: Time of day vs. power (kW). Here, the maximum power generation is at nearly 250 kW at 13 hrs., and power dispatch is at 230 kW at 12.5 hrs. Here  $P_{gen} > P_d$ , the battery charged more time, but discharging time was less compared to individual power generation systems of solar and wind. The combined hybrid power system capacity is effectively utilized to improve its useful lifetime. The combined hybrid power systems capacity is effectively utilized to improve its useful lifetime. The LPSP ratio of 2.8% only. The VRB battery aids the hybrid renewable generation to meet the scheduled dispatch effectively.

The above Figure 16 shows that Time of Day vs. Discharge Battery power According to the flow of batteries, they can discharge for up to 10 hours at a stretch, whereas most other commercial battery types are designed to discharge for one or two hours at a time. The maximum discharge is 6 hours at 100 kW, and the minimum is 10 kW at 5 hours.

The above Figure 17 shows the Time-of-Day vs. Charge Battery power as the redox flow batteries use liquid phase reduction and oxidation reactions when liquid electrolyte flows through the electrodes. The used electrolyte can be recharged by pumping it back through the electrodes to the tanks. The maximum charging of the battery.

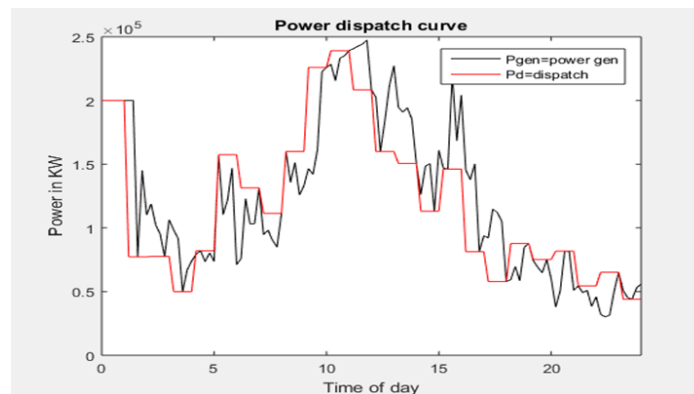

Figure 15 Time of day vs Hybrid power dispatch curve.

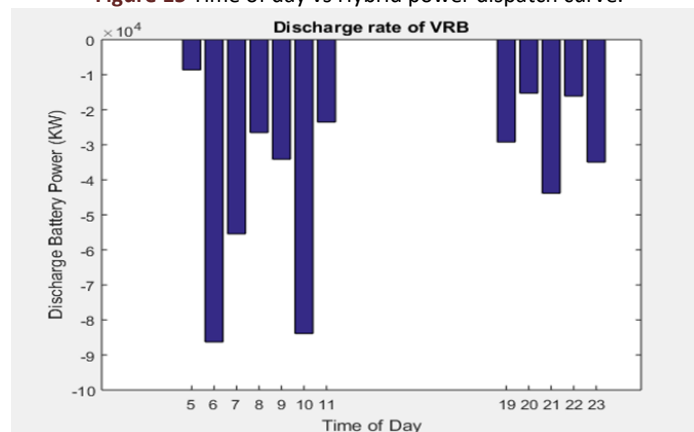

Figure 16 Time of Day vs Discharge Battery Power.

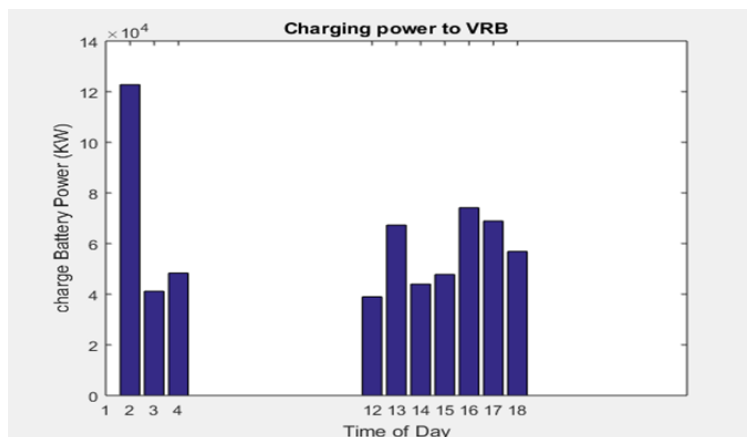

Figure 17 Time of Day vs Charge Battery Power.

The above Figure 18 shows the Time-of-Day vs. Battery power VRB (Vanadium redox battery rating). It is a rechargeable flow battery that employs vanadium ions as charge carriers. There is no limitation on energy capacity and the battery can remain discharged indefinitely without damage; it has a relatively poor energy-to-volume ratio compared to standard storage batteries. The maximum VRB power rating was 2 hours, 122 kW battery power, and the minimum was 5 hours, 50 kW, and there are no fluctuations in between. The capacity is being put to good use, lengthening the battery life span, which was increased.

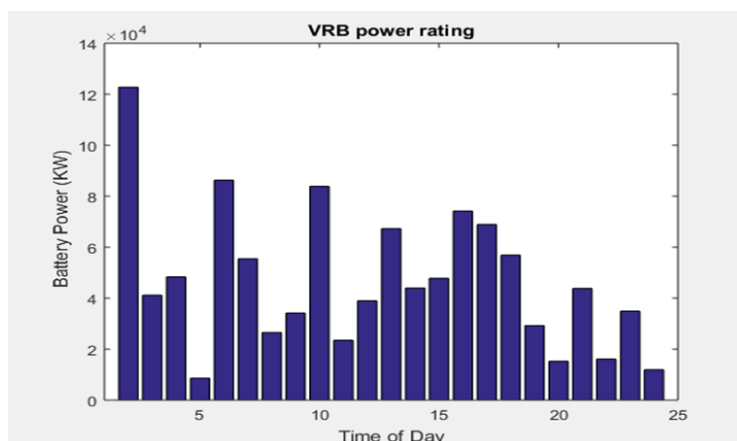

Figure 18 Time of Day vs Battery Power of VRB.

### 6. Conclusions

Large-scale grid-integrated renewable energy storage with flow batteries is becoming more prevalent. This study uses a modified min-max dispatch algorithm that accounts for peak demand periods to estimate the optimal size for a VRB battery. Real-time data from a 275-kW wind PV HRES was used to evaluate the methods, and the results were recorded. The battery can be kept from being overcharged or undercharged with the use of an energy management system. The performance indicates that the battery life is optimal when there are as few charge and discharge cycles as possible. One potential next direction for this work is to analyze how battery storage devices control the emission of forecast mistakes in wind data. Maximum power rating of 75 kW for 12 hours and a minimum power rating of 125 kW for 5, 11, or 20 hours of solar energy every day. Minimum power rating of 100 kW for 5, 11, or 20 hours and a maximum power rating of 180 kW for 2 hours. The power rating indicates how much of a sudden demand each wind energy source can meet. There are no variations in hybrid renewable energy; the maximum VRB power rating was 2 hours, 122 kW battery power, and the minimum was 5 hours, 50 kW. Ultimately, hybrid renewable energy performs better than other types.

### Nomenclature

- TSO: Transmisson system operator.
- PWBHPS: Transmisson system operator.
- VRFB: Vanadium redox flow battery.
- Soc: State of charge.



DG: Distributed generation.

### **Ethical considerations**

Not applicable.

### **Conflict of Interest**

The authors declare no conflicts of interest.

### **Funding**

This research did not receive any financial support.

### **References**

- Ahead C (2017) Battery Energy storage. Michael Weinstein.
- Alexandre Lucas SC (2016) Smart grid energy storage controller for frequency regulation and peak shaving, using a vanadium redox flow battery. *International Journal of Electrical Power & Energy Systems* 80:26-36. DOI: 10.1016/j.ijepes.2016.01.025.
- Boss S (2018) Project-Based Teaching: How to Create Rigorous and Engaging Learning Experiences. USA: ASCD.
- Chun TW (2015) Cost Optimized Battery Capacity and Short-Term Power Dispatch Control for Wind Farm. *research gate*. DOI: 10.1109/TIA.2014.2330073.
- Engineering: Issues, Challenges, and Opportunities for Development (2010) Germany: UNESCO Publishing.
- J Leahy M (2010) Wind storage technologies. *WIT Transactions on State of the Art in Science and Engineering*.
- KC Divya JØ (2009) Battery energy storage technology for power systems. An overview, *Electric Power Systems Research* 79:511-520.
- Mohammad Reza Maghami AG (2023) Challenges associated with Hybrid Energy Systems: An artificial intelligence solution, *Energy Reports* 924-940. DOI: 10.1016/j.egy.2022.11.195
- Nameer Al Khafaf JW (2023) A deep learning approach for detecting distributed generation in residential customers, *Sustainable Energy, Grids and Networks* 33. (DOI: 10.1016/j.segan.2022.100966
- Puleston T, Clemente A, Costa-Castelló R, Serra M (2022) Modeling and Estimation of Vanadium Redox Flow Batteries: A Review. *Batteries*. DOI: 10.3390/batteries8090121
- Xiangguo Xu ZZ (2023) Design and multi-objective comprehensive evaluation analysis of PV-WT-BG-Battery hybrid renewable energy systems in urban communities. *Energy Conversion and Management X*:18. DOI: 10.1016/j.ecmx.2023.100357.
- Yang Li MV (2020) Design of minimum cost degradation-conscious lithium-ion battery energy storage system to achieve renewable power dispatch ability. *Applied Energy* 260. DOI: 10.1016/j.apenergy.2019.114282.